



THE COVES GOVERNING BODY NPC



ARCHITECTURAL GUIDELINES

AERO COVE

Revised: November 2020

Contents

1. INTRODUCTION	3
2. DEFINITIONS AND ABBREVIATIONS	3
3. OBJECTIVES	4
4. WORK REQUIRING PERMISSION	4
5. PROCEDURE	4
5.1. Plan Submissions	4
5.2. Site Survey	4
5.3. Requirements for Building Commencement	5
5.4. Sign-Off and Occupation	5
6. NON-COMPLIANCE	5
7. TOWN PLANNING CONTROLS	6
7.1. Density	6
7.2. Floor Area Ratio (Refer to each stand's Zoning Certificate)	6
7.3. Coverage (Refer to each stand's Zoning Certificate)	6
7.4. Height Restrictions	6
7.5. Levels	6
7.6. Loft Guidelines	6
7.7. Double Storeys	7
7.8. Building Lines and pedestrian servitude	7
8. ARCHITECTURAL STYLE	7
8.1 Plan Forms and Appearance	7
8.2 Structure Material	7
8.3 Windows, Doors and Handrails	8
8.4 Garages and Carports	8
8.5 Roofs	9
8.6 Gables	9
8.7 Chimneys	9
8.8 Structures other than houses and outbuildings	9
8.9 Paving	10
8.10 Outbuildings and Kitchen Yards	10
8.11 Fencing and Boundary Walls	11
8.12 Unit Identification	11
8.13 Soil and Waste Pipes	11
8.14 Utilities	11

8.15	Exterior Lighting.....	13
8.16	Landscaping / Pedestrian Servitude	13
8.17	Green Belt Servitude / Common Area.....	13
8.18	Stormwater, Water and Sewerage Network.....	13
8.19	General Garden Features	13
8.20	Alternative building materials	14
9.	AIRCRAFT HANGERS.....	14
9.1.	Aircraft Hanger Construction.....	14
9.2.	Aircraft Hanger Configuration	14
9.3.	Hanger attached to Garage and House	14
9.4.	Hangar attached to the Garage	14
9.5.	Maximum Size of Hangars is:.....	15
9.6.	Hangar Ventilation System Guidelines	15
9.7.	Grouping & Composition	15
10.	BUILDERS AND CONTRACTORS GUIDELINES.....	16

Annexures:

- A. Plans Scrutiny Fees
- B. Aero Cove Checklist
- C. Coves Letter re Clearance Certificate
- D. Builders' Code of Conduct

1. **INTRODUCTION**

This document contains the Architectural Guidelines for Aero Cove of The Coves Governing Body NPC as per the Memorandum of Incorporation (Mol) and Rules. The main objectives of the Association also include the carry on, the promotion, the advancement and the protection of communal interests, the safety and welfare of the members of the Association, including, but not limited to, by maintaining the open spaces, controlling the aesthetic appearance of land and dwellings erected on the Property, including landscaping, buildings, alterations and improvements on the property, and other.

All designs will be subject to the submission of a Set of Plans to be approved by the Coves Architectural and Aesthetic Committee (ARAC). The final ARAC and Council approved plans, read together with the Mol, Rules, Guidelines and the National Building Regulations form the basis of agreement between the Association and the Member.

2. **DEFINITIONS AND ABBREVIATIONS**

Architectural Review and Aesthetic Committee – ARAC	means the committee established by The Coves Governing Body’s Board of Directors. The ARAC will consist of representatives of the Members, the Estate Architect, Management and further appointees by the Association
Architectural Guidelines	means the set of Architectural Guidelines incorporating the 'Builders Code of Conduct' which regulate the architectural style of buildings permitted on a stand in Aero Coves and the manner in which improvements may be made on a stand.
the Association	means The Coves Governing Body NPC (Reg. Number: 2003/010909/08).
Common Property	the roadways and pavements, as well as all the land and areas upon the Property which do not form part of the individual erven registered in the members’ names.
Council	means the Madibeng Local Municipality.
EMP	means the Environmental Management Plan, the Construction Environmental Management Plan, the Operational Management Plan and any other environmental management plans developed for the Property, together.
Estate Architect	means Marais 4 Architects, Contact person – Eben Marais (Tel. 087 942 2647 and e-mail: eben@marais4.co.za).
Estate Rules	means the Rules laid down for the use, enjoyment and management of the Property.
Freehold Coves	means Aero Cove; Bass Cove; Fish Eagle Cove; Heron Cove; Mountain Cove and Woodlands Cove.
Management	means the Estate Manager, Security Manager, Operations / Maintenance Manager and Building Control Officer.
Member	Membership of the Company shall be limited to a person who is in terms of the Deeds Registries Act reflected in the records of the Deeds Office concerned as the registered owner of any residential stand, the members of Olive Tree Body Corporate, Oyster Cove Bodies Corporate and Plover Cove Body Corporate.
Mol	means the Memorandum of Incorporation.
NBR	means the National Building Regulations and Building Standards Act
NHBRC	means National Home Builders Registration Council
the Property	means the entirety of the Coves Estate, comprising of The Heron Cove Township proclaimed in Government Gazette No. 6079 on 28 October 2004 and as indicated on General Plan (S.G. No. 9377/2002) (previously known as Portion 178 of the Farm De Rust 478 JQ) and The Coves Township (Kosmos Extension 7) as proclaimed in Government Gazette No. 6097 on 11 January 2005 and as indicated on General Plan (S.G. No. 5219/2004) (previously known as Remainder of portion 177 of the Farm De Rust 478 JQ);
Stand	means a freehold erf situated upon the Property duly demarcated on a Land Surveyor General diagram.

3. OBJECTIVES

The objective of these Guidelines is to effectively control the design of individual dwelling units in order to achieve the following:

- 3.1 To have each unit fit in and contribute to the unique character and style of the village that is created within the Property;
- 3.2 To protect the rights of neighbouring owners by maintaining privacy and to avoid the obstruction of intend views and visits of each co-owner and;
- 3.3 To maintain an exceptional high standard of design and workmanship in the construction phase throughout the Property.

4. WORK REQUIRING PERMISSION

No vacant stand shall be developed and no existing improvement on a portion shall be extended or altered in a manner or style inconsistent with the Architectural Guidelines detailed herein.

Any member intending to carry out any of the following activities must obtain prior written approval from the ARAC:

- 4.1. new buildings and all structural, aesthetic and external alterations to existing structures;
- 4.2. painting and repair of external facades;
- 4.3. awnings, projecting roofs and trellises;
- 4.4. garages, carports and driveways;
- 4.5. swimming pools and external paving;
- 4.6. walls, gates or any landscape construction

5. PROCEDURE

5.1. Plan Submissions

- 5.1.1. All designs will be subject to the submission of a Set of Plans to be approved by the ARAC.
- 5.1.2. A scrutiny fee, to be determined by the Association from time to time, will be payable to the Association, with the first submission. Please see Annexure A – “Plans Scrutiny Fees”.
- 5.1.3. Plan submissions and changes are reviewed every two weeks by the ARAC.
- 5.1.4. Drawings submitted must be to scale and must indicate materials and colours elected. Where there are existing buildings on adjacent sites, these must also be shown.
- 5.1.5. Plan submissions must indicate the site contours on the site plan and all elevations.
- 5.1.6. These drawings must be of a professional nature, suitably detailed and must comply with the NBR. The ARAC may request the South Africa Council for the Architectural Profession registration to be provided on submission of drawings.
- 5.1.7. At least three copies of all full size (minimum A1) drawings must be submitted to ARAC for approval, together with the submission checklist. All buildings to be erected on stands will be on completion, subject to an engineering certificate issued by a professional engineer.
- 5.1.8. A stamp of approval from the ARAC must be obtained before documentation can be submitted to the Council.
- 5.1.9. Once approval from the Council has been obtained, a set of the approved plans must be submitted to Management and a soft copy of the approved plans must be submitted to Management via email to community@thecoves.co.za.
- 5.1.10. ARAC plan approval for houses, alterations to houses and or specialist work shall be valid for a period of 24 months from the date that they were officially stamped by the HOA. If no construction has commenced within 12 months of the date of approval, plans will need to be re-submitted for approval to the Council as the Council’s approval is valid for a 12-month period only.

5.2. Site Survey

- 5.2.1. All Portions must be surveyed by a Professional Land Surveyor appointed by the Member. Surveys should clearly indicate the following:
 - stand boundaries;
 - contours at minimum 500mm intervals;
- 5.2.2. The identification of the Portion pegs may only be done by a Professional Land Surveyor; appointed by the Member. The correct positioning of the dwelling is the responsibility of the Member.
- 5.2.3. A Professional Land Surveyor must peg the building footprint and must also confirm that the foundations have been correctly positioned.
- 5.2.4. The Land Surveyor will also be required to submit an as-built plan confirming the correct position of the construction or sign off the approved site plan confirming the correct position of the building.

5.3. Requirements for Building Commencement

- 5.3.1. Please see the Builder's Code of Conduct for the full requirements.
- 5.3.2. The Member shall give Management at least 2 weeks' notice of their intent to start building and provide the following information before commencement:
 - i. A copy of the Architectural Guidelines and Builder's code of conduct, signed by the Member and Contractor;
 - ii. A copy of the Estate Rules and Penalties, signed by the Member and Contractor;
 - iii. Payment of the building performance deposit;
 - iv. Payment of the sewer and water connection fee;
 - v. A copy of the working drawing as approved by the Council;
 - vi. The Contractor's NHBRC Registration Certificate;
 - vii. The Contractor's NHBRC Certificate of Registration for this building contract;
 - viii. A copy of the Contractor's All Risks and Public Liability Insurance Policy.
 - ix. Confirmation of the Contractor's Health and Safety File.
 - x. Contractor's Letter of Good standing with the WCA.

5.4. Sign-Off and Occupation

- 5.4.1. Each architect submitting plans to the ARAC must (at the end of the build) provide the ARAC with an architectural completion certificate (signed by the appointed architect) as well as the prescribed form approved by the ARAC indicating that the completed project complies with all aspects of the Architectural Guidelines; and that the project is built as per the approved plans.
- 5.4.2. Copies of the relevant compliance certificates (structural and roof, electrical, gas, glazing, plumbing) must be provided at the final inspection for the Company's record keeping purposes.
- 5.4.3. Provided that all conditions and requirements have been met, a Certificate of Completion will be issued by the ARAC.
- 5.4.4. Unless and until such Certificate of Completion is issued, the Member may not occupy the house or outbuildings, and the Association reserves its rights to take any such measures deemed appropriate against such occupancy; and
- 5.4.5. For the re-sale of existing or completed houses, the Association shall inspect and verify compliance of the house with its approved plans and ensure that no illegal alterations or additions have been done. This verification to be provided before the Association issues its levy clearance certificate.
- 5.4.6. Every project, regardless of the type of project (addition, alteration, as built or new) will require a certificate of completion from the Coves HOA and an occupation certificate from Madibeng.

5.5. Please see Annexure B – Aero Cove Checklist.

5.6. Please see Annexure C – The Coves Letter re Clearance Certificate explaining the sign-off procedure, including the documents needed for the Association (ARAC) to issue the Clearance Certificate.

6. **NON-COMPLIANCE**

- 6.1 Members remain responsible for all improvements on their portions and must ensure that their architects and contractors comply with all rules.
- 6.2 No precedent may be used as an example to validate not following the guidelines or to sway the ARAC to accept a proposed or "as built" transgression of the guidelines.
- 6.3 The ARAC views non-compliance with the Architectural Guidelines and or approved plans in a very serious light.
- 6.4 In cases of non-compliance during or after construction a non-compliance certificate will be issued where deemed necessary. Rectifications must be made at the member's cost within the provided time frame. Should the necessary work not be affected timeously, monthly penalties as determined by the Company may be levied until such work has been carried out to the satisfaction of the ARAC.
- 6.5 Concession to any of the architectural guidelines is at the sole discretion of ARAC and the Board of Directors.
- 6.6 Rectifications must be made at the member's cost within the provided time frame.
- 6.7 Should the necessary work not be affected timeously, monthly penalties as determined by the Association may be levied until such work has been carried out to the satisfaction of the ARAC.
- 6.8 Any omission or error on the part of the ARAC when scrutinizing the plans shall not preclude the Member from complying with the Mol, Rules, Architectural Guidelines, Council restrictions and NBR.
- 6.9 Building Time – Limit

- 6.9.1 Construction shall be completed within 12 (twelve) months from the date of commencement. Commencement in this context shall be from date of site handover.
- 6.9.2 Construction timelines applicable for Renovations, Additions & Alterations:
 - Internal Renovations/Alterations and small additions of less than 100 sqm Building – 6 Months
 - Additions/Alterations of over 100 sqm 12 Months
- 6.9.3 Penalties will be applicable if the project is not completed and signed-off within the periods indicated above.

7. TOWN PLANNING CONTROLS

The restrictions set out below are in addition to conditions of the Title Deed, Town Planning Schemes or National Building Regulations. Notwithstanding with the above approval of plans is to the sole discretion of the ARAC.

7.1. Density

One residence / dwelling per stand.

7.2. Floor Area Ratio (Refer to each stand's Zoning Certificate)

- 7.2.1. Maximum area ratio (bulk) that may be erected on a stand not to exceed factor of 0.5. All spaces which are covered, as well as habitable loft spaces will be included in FAR calculations
- 7.2.2. Mezzanine floors fitted retrospectively in double volume spaces above or equal to 3230mm need to be included in FAR calculation and not exceed the permissible ratios.
- 7.2.3. A standard size double garage (42 m²) and or boathouse/storeroom (not exceeding 40 m²) will be excluded for the purpose of calculating Floor Area Ratio (FAR) in terms of the ARAC approval.

7.3. Coverage (Refer to each stand's Zoning Certificate)

Permitted coverage on site is 30%, the minimum house size is 350m² excluding hangers.

7.4. Height Restrictions

- 7.4.1. Maximum Overall Height to Apex of Roof is applicable to all Stands
- 7.4.2. Height will be measured from Natural Ground Level:
 - Single Storey: 6700 mm
 - Hanger: 6700mm
 - Double Storey: 10 000 mm

7.5. Levels

- 7.5.1. No excavation or filling that may alter the natural ground levels may be undertaken without the written approval of the ARAC.
- 7.5.2. To address the height of overall structures the following requirements are applicable to the current overall height requirements and wall plate restrictions:
 - i. The overall height restrictions will remain the same.
 - ii. The height of the finished floor level at ground level may not exceed 900mm above natural ground level.
 - iii. If any overlooking is caused by the raised floor levels the owner must obtain approval from the neighbours prior to submission to the ARAC.
 - iv. The ARAC may take any action necessary to rectify the transgression if the neighbour is negatively affected by the change in level. This may include using the building deposit to endeavour to rectify the privacy of the neighbour.

7.6. Loft Guidelines

- 7.6.1. Loft wall plate height may not exceed 4500mm with a single storey; and 6460mm height with a double storey.
- 7.6.2. Loft to be in roof space
- 7.6.3. Loft to not appear as a double storey element, but to be concealed within a single storey roof void
- 7.6.4. Overall height of building to be within the guideline.
- 7.6.5. No more than 20% of the ground floor
- 7.6.6. To be included in the F.A.R calculation
- 7.6.7. No balconies may be constructed from a loft space unless the same patio is shared by another space.

7.7. Double Storeys

Double Storey is permitted, but only 60% of the ground floor area may be built on the second floor.

7.8. Building Lines and pedestrian servitude

With any proposed building line relaxations, special consent is to be obtained from the ARAC, as well as from the Council for any relaxation. Applications for relaxation of side building lines will only be supported by the ARAC, with the consent of the next-door neighbour / owner of the effected stand. Relaxation of the street building line from 4.5m to 3m will only be considered with a motivation and Board approval is required.

- 6m on sides and back
- 10m on street boundary
- 16m Provincial Road (P31-1)
- 16m from centre of Erf 253 the Coves (Main Road Reserve)

Pedestrian Servitude:

See the site layouts. The Common area is solely for walk-through and landscaping purposes; no structure may be built on this area. This will always be under the control of the Coves Homeowners Association (HOA).

8. ARCHITECTURAL STYLE

The overall design concept for Aero Cove intends to recreate a Farm style village. Hangars with aircraft can be placed at each dwelling. The hangars must have a barnlike character. The architectural style has been developed by the architects to create a specific atmosphere, with a high-quality nature orientated lifestyle in mind. Elements of style are intended to create a vibrant homogeneous village, with enough variation to allow individuality and expression of personal taste. The cover perspective illustrates the trend of the architectural style, while the sketches define the intended detail.

8.1 Plan Forms and Appearance

Plan forms are to be from a basic rectangular form with diagonal lines or elements permitted and the objective of the forms should be to form a protected veranda area. There will be stoep or veranda areas to each house, which should be orientated towards the view: the fields and dam in background. It must be noted that: the views from any stand cannot be protected at the expense of the development rights of any other stand.

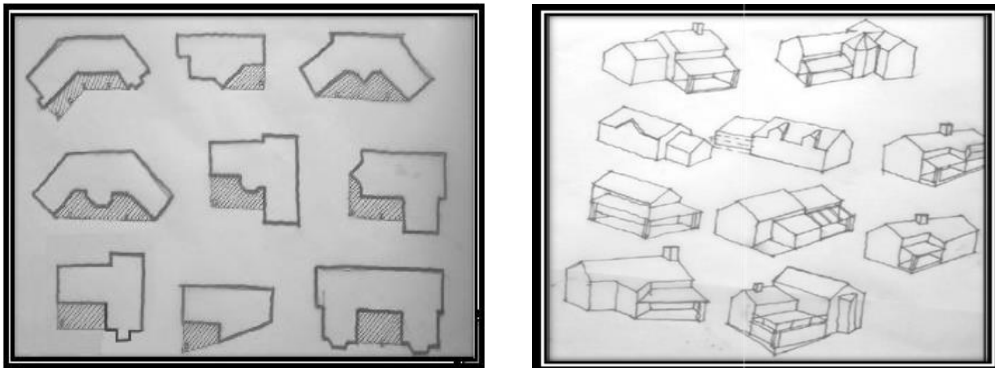

The mass of the houses must combine gable structures with add-ons: verandas, balconies, bay windows, tower elements, etc., such as shown above.

8.2 Structure Material

The house must be constructed out of brick and mortar. External walls are to be constructed of one of the following or a combination of these:

- 8.2.1. Natural stone material naturally available on site, or such natural stone can be used as cladding of brick masonry walls.
- 8.2.2. Artificial rock or cladding products may be considered after careful investigation, and the written approval of the ARAC.
- 8.2.3. External walls can also have coloured roughcast plaster, or plaster and painted walls in a certain colour range, blending with natural stone and the environment, to the approval of the ARAC. (Earth colours).
- 8.2.4. Semi-Face brick can be used on features and in certain colours only. The type and colour of brick should be pre-approved by the ARAC. Semi face bricks must be used in combination with plaster work and/ or stonework and

must be the less than 30% of all the wall finishes calculated per elevation.

8.2.5. Paint swatches must be pre-approved by the ARAC; prior to painting.

8.3 Windows, Doors and Handrails

8.3.1. The following non-reflective glazing will be permitted:

- Clear
- Low-E
- Low Tint Performance Glass (grey colours)

Mirrored or reflective tinting will not be permitted.

8.3.2. Wooden window frames may be painted white or shades of grey or sealed in a natural wood finish.

8.3.3. Windows are to be timber framed (stained and or/ sealed to a natural wood colour) or aluminium (bronze, brown, white or shades of grey powder-coated), with a vertical proportion.

8.3.4. Large openings will be encouraged towards the view-area, keeping in mind sun protection with large roof eaves, veranda and pergolas.

8.3.5. Smaller openings may be different proportions, but the elevation must be predominantly vertical windows.

8.3.6. The windows and doors must match in colour.

8.3.7. Because there will be monitored security of the total Development, the use of burglar bars is discouraged. If required, however, burglar bars will be permitted on the insides of windows only.

8.3.8. Doors shall be of traditional proportions for single or double doors, and must be varnished, stained and sealed or oiled timber or match the window colour.

8.3.9. Doors may also be fitted with shutters, if required.

8.3.10. Handrails are to be constructed of timber hardwood, with timber or painted steel posts.

8.3.11. All handrails will be varnished and fixed in such a way that no unsightly rust marks are left on surrounding surfaces.

8.3.12. No glass or Stainless-steel handrails will be permitted as this deviates from the farm style theme.

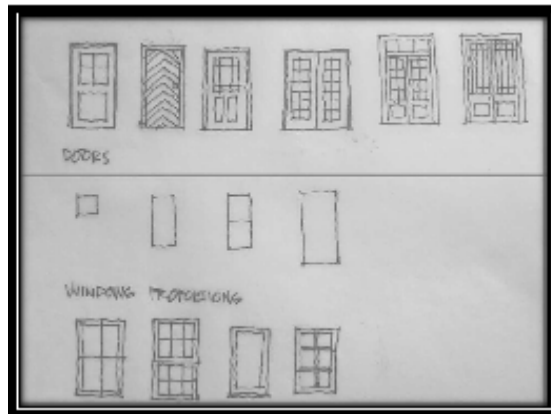

8.4 Garages and Carports

8.4.1. The roof of the garage or carport must fit in with the roof of the house.

8.4.2. No awnings or shade netting is allowed for carports, the ARAC must approve all carports and garages.

8.4.3. Doors for garages may either be 2 x single 2440mm in width with a centre column between doors, or up to a maximum of 5,500mm if a single double door.

8.4.4. Doors must be horizontal slatted timber doors (stained and/or sealed to a natural wood colour).

8.4.5. No square or rectangular panelled doors will be permitted.

8.4.6. Only 2 doors are allowed side by side on any elevation at the ARAC's discretion.

8.4.7. No roller shutter doors are permitted.

8.4.8. Timber farm style doors are allowed

8.4.9. Chromedek steel/aluminium are doors are allowed as long as they are wood colour or a colour to match the window frames, either with a wood grain, textured or matt finish.

8.4.10. No gloss or flat doors will be permitted.

8.4.11. No glass or glazed sections will be permitted in any garage doors

8.4.12. All freehold stands are to have a minimum of 2 garages.

8.4.13. Hanger doors are to be sliding or folding horizontally slatted timber doors (stained and/or sealed or a natural wood colour).

8.5 Roofs

Roofs are to be one of the following:

8.5.1. S-rib corrugated pre-painted chromadek roofs, in combination with small sections of flat concrete roofs where required.

- i. Concrete roofs should not exceed 25% of the total roof area.
- ii. No IBR roofing will be allowed.
- iii. Gutters to be powder coated steel or powder coated aluminium to match roof colour or fascia colour.
- iv. Pitched roofs are to be 25-35-degree angle with the aforementioned sheeting.
- v. The colour of the roof Sheeting is to be from the following range:
 - Chromadek Range of green or grey colours

8.5.2. Concrete roof tiles in the following 'Marley' profiles or similar:

- i. Double Roman
- ii. Ludlow
- iii. Mendip
- iv. Modern
- v. The following colour range is acceptable for Concrete roof tiles:
 - Slate or Granite grey

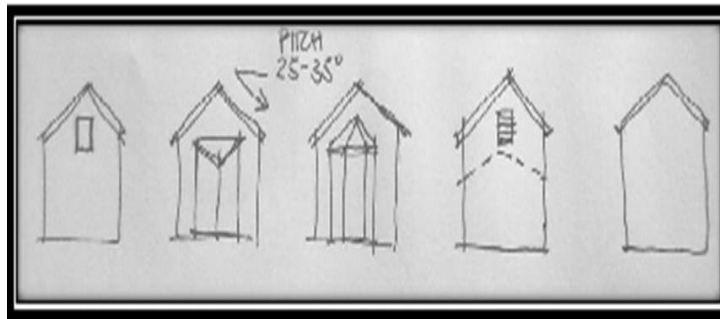

8.5.3. House to be designed to form a farm style character with gables and barn-type proportions. As previously mentioned, the gables always have an element in the centre of the gable, such as

8.5.4. window, louvers or bay window plus roof element.

8.5.5. Flat concrete roofs, to be the exception as a portion of the roof, for example for verandas, are to be covered with gravel or pebbles, in all situations.

8.5.6. Should overhangs be concealed, ceilings to be constructed of timber T&G or timber slatted, can be treated SA Pine.

8.6 Gables

Gables, as shown above, are to be built on each end of the roof; no hipped roofs are allowed to be able to create a homogeneous style. The gables must have an element in the centre of the gable, such as window, louvers or bay window.

8.7 Chimneys

Chimneys are to be constructed of natural stone, semi-face brick or coloured plastered brickwork, with copings as per detail. Jet master type chimneys with rotating or fixed cowls are also permitted.

8.8 Structures other than houses and outbuildings

8.8.1. Temporary or permanent structures including but not limited to huts, tents, shade canopies, prefabricated timber or steel structures or storerooms will not be permitted.

8.8.2. No fixed or aluminium, plastic or metal awnings, screens or coverings of any sort will be permitted.

8.8.3. Canvas roll-down awning systems may be used on veranda/patio areas to provide screening and protection from weather elements. Roll-down awnings will be permitted in the following colours:

- Natural Canvas
- Canvas colour to match the walls of the house

The following awning or shading systems are not be permitted:

- Overhead awnings

- Rectangle Fold Arm Awning
- Drop Arm Awning
- Perspex awnings
- Coolaroo systems or tented awning systems
- Louvered awnings will not be permitted.

8.8.4. Any structure with a foundation or dug into the ground to form a base will be defined as a permanent structure. These structures must be indicated on your building plan and may not be built within the building lines.

8.8.5. Verandas, pergolas, gazebos, balconies, cantilevered structures, external staircases or structures higher than 300mm are in general considered to be part of the building structures and must be within the building lines.

8.8.6. The Plan to be submitted to the ARAC for approval must include:

- Position on site plan showing position in relation to building and boundaries.
- Building lines and servitudes must be noted.
- A plan view showing types of materials and sizes.
- A roof plan showing sizes and beam configuration layouts.
- Relevant elevations and one section.

8.8.6.1. Verandas and Patios

- a. Roof to match existing
- b. Structure to match aesthetics of the house
- c. Brick, steel or square cut timber columns permitted

8.8.6.2. Pergola's

- a. A Pergola is defined as an unroofed structure and except for beams, it must be open to the sky.
- b. Pergolas and external timberwork to be varnished timber or Carbolineum or Tanalith treated poles.
- c. Steel pergolas are only permitted if the structure aesthetically matches the design of the house. Simple square or rectangular steel columns need to be clad in timber (or similar material) on at least 2 sides and match the aesthetics of the house.
- d. Pergolas may be covered with timber slats or bamboo as long as it matches the aesthetics of the house. Translucent plastic sheeting (or similar material) is not permitted. It is encouraged that pergolas also be covered with traditional decorative creeper.

8.8.6.3. Brise Soleil Structures

These structures will be considered upon submission to ARAC.

8.8.6.4. Gazebo's

- a. A gazebo is defined as a garden structure or pavilion with a roof. It must be free standing and open sided.
- b. The roof and structure to match existing roof and aesthetic finish of the house.
- c. Columns to be constructed from brick and plaster to match house or steel- to be clad with timber.

8.8.6.5. Decks

- a. Decks higher than 500mm above natural ground level will only be considered if not intrusive to neighbours.
- b. Decks are to be constructed with natural wood or composite alternative.
- c. Deck plans must be approved of by the ARAC.

8.9 Paving

8.9.1. Site paving from the road to the front of the house to be natural clay brick.

8.9.2. No concrete blocks or bg-blocks (grass inserts) can be used for driveways.

8.9.3. A strip of paving 1,2 meters wide shall be constructed around the perimeter of the building, in order to collect and discharged stormwater from the roof's overhang.

8.9.4. If gutters are fitted the ARAC may consider reducing the paving strip.

8.9.5. A maximum of 10 meters uninterrupted paving is permissible. Planters to be positioned to create a break in the paving surface.

8.9.6. Care should be taken in the design to ensure that sufficient visitors parking exist behind garages, to avoid parking of vehicles inside the road reserve.

8.10 Outbuildings and Kitchen Yards

All dwellings must have an enclosed drying yard/dustbin area, completely enclosed with 1.8m walls to provide adequate screening from neighbouring owners.

- i Washing lines must be positioned inconspicuously and out of site from neighbours and the road.

- ii The position of the washing lines or the alike must take into consideration the visual appeal and must be screened from neighbouring properties.
- iii Gas installations must comply with the SANS10400 and must be indicated on the plans.

8.11 Fencing and Boundary Walls

- 8.11.1. Properties may be fenced in, but limited fences are allowed: See diagram. All these should be treated natural timber or coloured plastered walls or semi-face brick as feature panels in walls.
- 8.11.2. Boundary walls to be finished on both sides to the satisfaction of the ARAC.
- 8.11.3. No fence or wall may extend over any property boundary.
- 8.11.4. All boundary walls and fences are subject to approval by the ARAC. The following finishes are not permitted on any boundaries:
 - i. Prefabricated concrete walling
 - ii. Steel palisade fencing
 - iii. Electric fencing, razor wire or security spikes
 - iv. Sculptures on top of walls
 - v. Paint “effects” to plastered walls
 - vi. Diamond mesh fencing
- 8.11.5. The height of a boundary wall is restricted to 1.2m on the ends of the stand with a 4.5m turning around the corners.
- 8.11.6. Walls of 1.8m height are allowed as per the diagram between houses and in line with the house-structure.
- 8.11.7. It is to be noted that the approval of boundary enclosure is to be approved at the sole discretion of the ARAC.
- 8.11.8. Boundary walls must be plastered and painted on both sides where there is no neighbouring house. If pole fences need to be secured only Bonnox or Welded Mesh will be allowed.
- 8.11.9. All retaining structures and walls around all buildings or parking areas, service yards etc. are to be constructed of brickwork plastered or natural stone
- 8.11.10. Where any swimming pool or a water feature is provided on a property, the property must then be screened in an approved manner in accordance with SANS 10400-2011 (Public Safety).
- 8.11.11. Gates
 - 8.11.11.1. Gates must be of a typical farm style type with welded Bonnox mesh, or timber panels.
 - 8.11.11.2. If the gate is motorized, the gate motor must be on the inside of the gate.
 - 8.11.11.3. Height of the gate may not exceed 1.2m.
 - 8.11.11.4. Plans must be formally submitted to the ARAC for approval.
 - 8.11.11.5. Colour and finish must be approved by the ARAC.

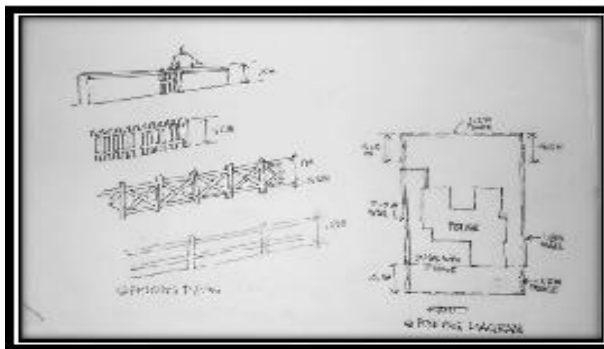

8.12 Unit Identification

A standard identification number for each unit, in solid brass or anodised aluminium, will be displayed in an obvious position to the approval of the ARAC.

8.13 Soil and Waste Pipes

Soil and waste pipes are to be concealed and should not be visible from beyond the site. All ducting is to be internal.

8.14 Utilities

- 8.14.1. Aerials and dishes
 - i. Aerials are to be contained within the roof space.
 - ii. Dishes to be erected in an inconspicuous spot away from the roads.

8.14.2. Solar Panels

- i. Solar panels are to be flush with the roof, and preferably mounted to be as inconspicuous as possible.
- ii. No heat pumps condenser units visible from any street will be permitted unless screened (subject to ARAC approval).

8.14.3 Rainwater tanks / JoJo tanks Guidelines

- i. Eco-friendly and aesthetically pleasing solutions for rainwater capture and rainwater harvesting are encouraged
- ii. The tanks may be integrated into the design of the house and may even take the form of a pond, a reservoir or be underground.
- iii. The second option is to harvest water by using JoJo water tanks. Alternative colours are Bushveld Green, Stormy sky and Winter Grass are allowed alternatively Khaki brown and Sandstone (See below JoJo tanks colour spectrum).
- iv. To mitigate visual impact all other tanks, need to be screened or clad in approved position and finish to the satisfaction of the ARAC.
- v. The position of the tanks must take into consideration the aesthetics and the practicality of the guttering and downpipes.
- vi. All tanks must be screened from neighbours unless used as an aesthetic feature. Only corrugated water tanks will be considered as an aesthetic feature.



8.14.4. Air-Conditioning

- i. Members are encouraged to put them central to the property hidden within the roof structure/lines as much as is practically possible. The top of air conditioning units should be positioned no higher than 1,2m from ground level. If the air conditioning unit is visible from the road or cannot be positioned 1,2m from ground level, be boxed in with a screen to match the finish of the unit.
- ii. All pipes and cabling must be trunked and painted to match the external walls of the house.
- iii. A proposal sketch must be submitted to ARAC with the details of the position of the air-conditioning unit and type of screen, if in the event screening is required.

8.14.5. Cool breeze – air coolant units

- i. It is encouraged that Members opt for an evaporative cooling system with a far lower carbon footprint than a conventional air conditioner.
- ii. Please be aware of the fact that these systems have unsightly external ducting and units, which need to be incorporated into the design of the house, and not as an afterthought.
- iii. To mitigate visual impact the position of the compressor must take into consideration the aesthetics.
- iv. The key consideration is that they are not wholly visible to the neighbours or the street and should be positioned to minimize any noise factor to neighbours.
- v. Applications to be submitted to the ARAC and each application will be viewed on a case by case basis in line with the rules.
- vi. Members are encouraged to position the unit's central to the property and hidden within the roof structure/lines as much as is practically possible.

8.14.6. Generators

- i. Generators may be run between 6:00 and 21:00.
- ii. Generator must be “silenced” in some way to achieve typical targets of noise range between 50 and 70 dB at 7m from the source or be placed in a position to minimize the noise levels to neighbours.

8.15 Exterior Lighting

- 8.15.1. Lighting must illuminate the ground and must not cast light outside the property boundaries.
- 8.15.2. Cosmetic lighting should be positioned under 2.1m and in such a manner that illuminate the wall and ground below it and is not intrusive to neighbours.
- 8.15.3. An external lighting plan showing location and fitting-type of external lighting must be pre- approved.
- 8.15.4. Flood lighting and spotlights will only be permitted at Hartbeespoort Dam waterfront properties (stands 1-21 Heron Cove) facing the dam.

8.16 Landscaping / Pedestrian Servitude

- 8.16.1. Only indigenous plant species will be permitted.
- 8.16.2. Trees are to be carefully selected and positioned to minimize the obstruction of views of neighbouring owners.
- 8.16.3. The maximum height of trees within the building line areas and setbacks is restricted to 2 meters.
- 8.16.4. The service of a reputable Landscaping Consultant is encouraged.
- 8.16.5. Management must be consulted prior to any planting to ensure no trees are planted within any services.
- 8.16.6. Each Member shall be responsible for the landscaping and maintenance of the sidewalk adjacent his stand.
- 8.16.7. If the Member neglects maintenance of his sidewalk, the Association will execute the required work, and charge the Member for such work.

8.17 Green Belt Servitude / Common Area

- 8.17.1. The Common area green belt is solely for landscaping purpose, no structure may be built on this area.
- 8.17.2. All use of common ground must be approved in writing by the Association and by the immediate neighbours in writing.
- 8.17.3. Plants must be indigenous and water wise. No sprinkler systems are permitted in these areas.
- 8.17.4. No permanent structures are permitted within the common area.
- 8.17.5. The ground may not be fenced off from the rest of the common property.
- 8.17.6. Members are to ensure that plantings do not interfere with the Association’s service areas or farming operations.
- 8.17.7. Maintenance of these areas is the Member’s responsibility and they must be kept to a standard conducive to the rest of the Property.
- 8.17.8. Ownership of these areas does not at any stage devolve to a Member and the common property / green belt servitudes will always remain part of the Association.
- 8.17.9. No use by one Member will convey the right for another Member to have the same use as each case must be considered in relation to the aesthetics of the Property.
- 8.17.10. Requests to use green belt servitudes / common property need to be submitted to the ARAC.

8.18 Stormwater, Water and Sewerage Network

- 8.18.1. Stormwater is collected on internal roads and is dispersed to a suitable drainage course downstream of the Property.
- 8.18.2. All storm water and swimming pool back-wash water have to be discharged as per the Property’s bulk storm water plan.
- 8.18.3. No stormwater, swimming pool back-wash water or any rainwater may be discharged into the sewer systems.
- 8.18.4. Water reticulation network is provided with individual stand connections (water meters).
- 8.18.5. Fire Hydrants are provided on the Property for fire protection.
- 8.18.6. All stands will be connected to a piped sewerage reticulation, which will be connected to a common sewerage works.
- 8.18.7. All sewer connections to be done at the connection point provided; with the Associations’ approval.

8.19 General Garden Features

- 8.19.1. All external fitting and features i.e., garden features, ornaments, statues or alike and any other free-standing man-made elements should not be visible from the road.
- 8.19.2. Should water features and fountains be visible from the road, permission will need to be obtained from ARAC.
- 8.19.3. Jungle gyms, swings, trampolines and other play apparatus must be positioned within the building lines of the property. Consideration should be taken when positioning these types of apparatus and the visual impact they may have from the road, pivot, dam and or common property. A sketch to be submitted (accompanied by a site plan) with illustrations of the apparatus. Details of the position and description of the proposed apparatus

must be included on the sketch.

8.20 Alternative building materials

Alternative building materials may be considered by the ARAC in keeping with changes in building technology, where these materials have no effect on the overall intended look and feel of the Property. Such approval will be solely granted at the discretion of the ARAC.

9. AIRCRAFT HANGERS

9.1. Aircraft Hanger Construction

The hangers must be constructed from the same wall and roof material as the house or dwelling unit with emphasis on the style being like a farm type barn.

9.2. Aircraft Hanger Configuration

Refer to diagrams.

9.3. Hanger attached to Garage and House

The hanger may be attached to the outbuildings and the house as shown in the sketch below.

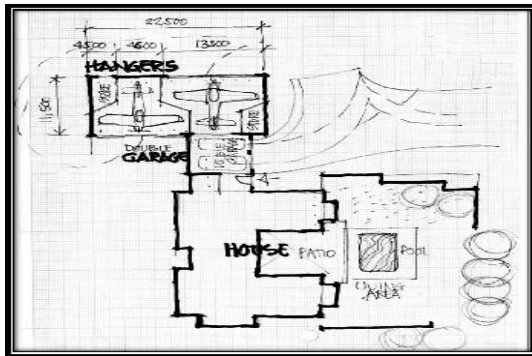

The hanger may be attached to the outbuildings and the group be detached from the house as shown in this sketch below.

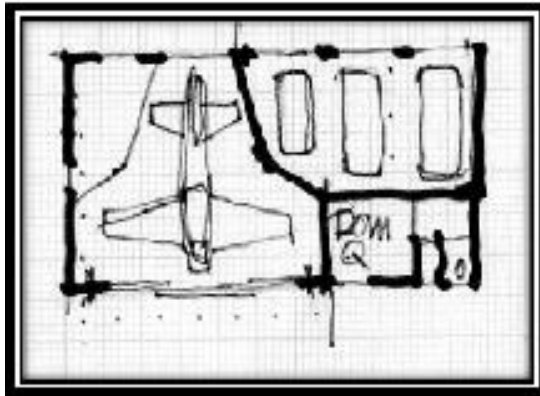

9.4. Hangar attached to the Garage

Outbuilding only with the domestic quarters attached to the dwelling house

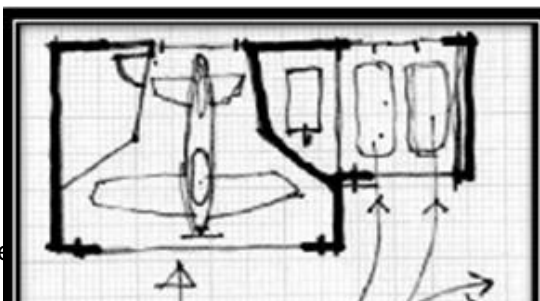

9.5. Maximum Size of Hangars is:

- 9.5.1. Hangar for 2 Light Aircraft 22.5m x 15m maximum (Internal dimensions)
 - 9.5.2. Hangar for 1 Light Aircraft 15m x 11,5m maximum (Internal dimensions)
 - 9.5.3. Hangar for Micro-Light Aircraft 8m x 7m maximum (Internal dimensions)
- Hangar design and dimensions are subjected to deviation with the approval from the ARAC.

9.6. Hangar Ventilation System Guidelines

- 9.6.1. The ventilation system is to be proportionate to the size (500mm or 610mm) of the hangar roof, colour and position to match the same.
- 9.6.2. The key consideration for positioning from an aesthetics perspective is that they are not wholly visible to the neighbours or the street and should be positioned to minimize any noise factor to neighbours.
- 9.6.3. The unit is to be placed central to the property hidden within the roof structure/lines as much as is practically possible.

A basic sketch of the size and position is subject to ARAC’s approval, prior to installation

Specifications of Ventilation Systems	500mm Minimum	610mm Maximum
Tested Air removing capacity at * 15km/h windspeed	4495m ³ /h	6807m ³ /h
*25km/hwindspeed m ² floor coverage per unit	5757m ³ /h 120m ²	8515m ³ /h 180m ²
Sealed bearings in Housing	2	2
No. of blades	32	40
Dome height	430mm	530mm
Dome width	660mm	815mm
Total height	870mm	910mm
Approximate mass: * Galvanised whirlybird * Zinalume whirlybird * Aluminium whirlybird	15.9kg 14.7kg 10.4kg	24.6kg 22.4kg 15.2kg

No roof ventilators may be used on a residential building and only applies to hanger structures.

9.7. Grouping & Composition

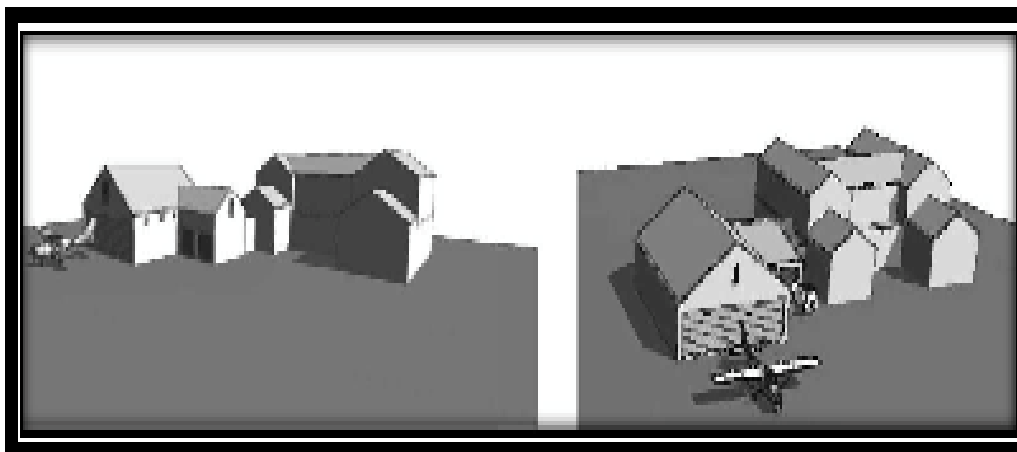

The above diagram indicates the preferred composition of light aircraft hangar and outbuildings linked to a dwelling which will differ from site to site.

10. BUILDERS AND CONTRACTORS GUIDELINES

Please see Annexure D – Builder’s Code of Conduct.

- 10.1. All contractors are to abide by the Builder’s Code of Conduct, Architectural Guidelines, EMP and Estate Rules as amended from time to time. It is the Member’s responsibility to ensure that the contractor is given access to all documentation. The owner of the property is responsible for the behaviour of and compliance with the rules of the contractors, any penalties imposed may be debited to the Member’s levy account. This applies to maintenance and additions as well as new builds. Application documents to be obtained from the Estate office.
- 10.2. All contractors must ensure that all work is done as per the approved plans and NBR.
- 10.3. All Contractors must take full responsibility for their building site’s Health and Safety, as prescribed by the Occupational Health and Safety Act.
- 10.4. Spot penalties may be imposed by Management or Security for non-compliance with the Builder’s Code of Conduct and Estate Rules.
- 10.5. If a contractor has incurred more than 3 penalties the contractor will be requested to attend a meeting with the Estate Manager, site manager and the Member who has appointed the contractor, if necessary, the security director or another director will be requested to attend.
- 10.6. The Association reserves the right of access.
- 10.7. All Builders / Contractors / Suppliers entering the Property are subject to The Coves’ Access Control conditions and procedures.
- 10.8. Contractors are permitted access Monday to Friday; 7:00 - 18:00, via the Contractor’s Gate.
- 10.9. In the event of an emergency where work is required outside these hours, application is to be made to the Estate Manager.
- 10.10. Building sites are to be kept clean and at no time is building material to be accumulated on site or on any adjoining vacant site.
- 10.11. The perimeter building fence or net is to be closed off to prevent injury to any person or child walking on site. The fence is to be kept in a good state of repair, neat and tidy at all times.
- 10.12. Every building site is required to have a chemical toilet, the toilet is to be provided prior to the building site been opened by the Association for work to commence. The toilet is to be serviced on a regular basis and kept in a good state of repair and adequately screened.
- 10.13. Builders taps are not to be left running when water is not being used. Any water leaks are to be reported to Management.
- 10.14. Contractors are not permitted to walk from building site to building site nor are they permitted to wander off the building site where they are working.
- 10.15. Contractors are to make use of the designated roads as when moving throughout the Property.
- 10.16. Only Security authorized vehicles will be allowed onto the Property. All delivery trucks, earth moving equipment TLB’s, and tractors are not permitted entry through the Main gate and must use the contractors Gate. Contractor vehicles and delivery trucks are to use the contractor roads provided and all delivery trucks must be escorted by the responsible contractor from and back to the contractors gate entry point. There is a load restriction of 8, 0 Ton G.V.M. (gross vehicle mass) single axle on all tar road surfaces where there is no contractor road provided. Double axle trucks will not be permitted on tar surface roads, exception to this is made for the delivery of ready-mix concrete trucks with the proviso that the contractor protects the road at turning points with crusher dust or similar soft sand to reduce the chance of tearing of the tar surface by the double axle. Excepting for roof truss deliveries, no articulated vehicles are permitted on the Property, unless by special prior authorization by Management.

It is the obligation of the Contractor to notify his suppliers of this, and the Association shall not entertain any claims for losses or damages in this regard.